

Special Products Group

Railcar Parts Catalog

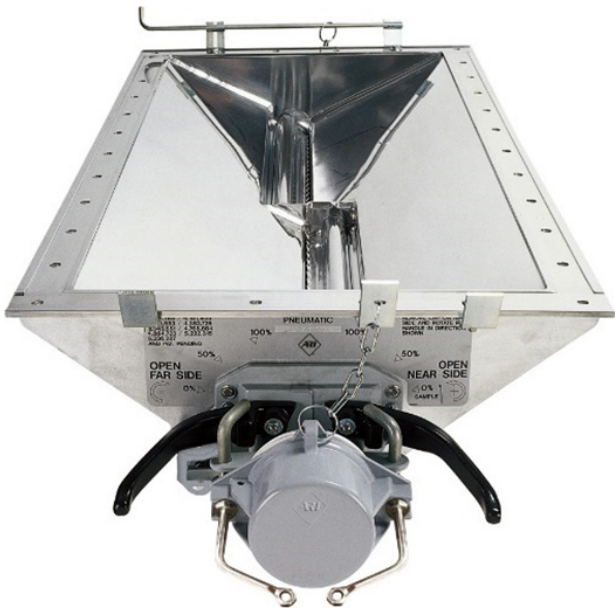

PHONE: 877.94.PARTS
TOLL FREE: 800.343.7188
FAX: 888.868.4793
EMAIL: grs.info@gbrx.com

One Centerpointe Drive, Suite 200
Lake Oswego, Oregon 97035

www.gbrx.com

THE
GREENBRIER
COMPANIES

General Ordering Information..... 3

GENERAL FREIGHT RAILCAR

Brake Pin..... 4
 Center Pin..... 4
 Center Plates 4
 Center Plate Bowl Liner (Horizontal) 5
 Coupler Carrier Wear Plate (Drop In)..... 5
 Coupler Carrier Wear Plate (Flat) 5
 Draft Gear Carrier 5
 Draft Key 6
 Draft Key Retainer & Keeper (Lock) 6

Draft Key Retainer & Lock..... 7
 Draft Key Slot – Reinforcement..... 7
 Draft Key Washer 7
 Follower Block – Y44 8
 Front Draft Lug 8
 Handhold, Adjustable – Double Bend..... 8
 Handhold, Adjustable – Single Bend..... 8
 Handhold, Adjustable – Straight 9
 Handhold, Double Bend..... 9

Handhold, Single Bend..... 10
 Handhold, Straight 10
 Roller Bearing Retainer 10
 Roping Staple 11
 Route Card Holder..... 11
 Striker Assembly..... 11
 Support Spring – Hand Brake Chain..... 12
 U-Bolt, Angle Cock 12
 U-Bolt, Pipe Clamp..... 12

COVERED HOPPER RAILCAR

Braided Flex Hose – Pressureaide® cars 13
 Camlock Connector –Pressureaide® Cars..... 13
 Camlock Swing-Bolts – Pressureaide® cars 13
 Hatch Cover, 30" Aluminum 14
 Hatch Covers, 20" Plastic and Aluminum 14
 Hatch Cover, 20" Vented 15
 Hatch Cover, Pressureaide® Cars..... 15
 Hatch Handle, Pressureaide® Cars..... 16
 Membrane, Pressureaide®, Trapezoidal 16
 Outlet Caps..... 17

Membrane, 5015 Outlet – Bottom Adapter Gasket 21
 Membrane Adapter Kit, 5015 Outlet..... 21

OUTLETS GRAVITY

5021C Gravity Outlet 22
 5097E and F Gravity Outlets 23
 5098D Gravity Outlet..... 24
 5124 AL Gravity Pneumatic Outlet with Sanitary Shield .. 25
 Outlets, Pneumatic
 5129A Pneumatic Outlet 26
 5230 Pneumatic Outlet..... 27
 5236 Pneumatic Outlet..... 28
 Adapters 28
 Gasket 29
 5134B Fluidized Pneumatic Outlet..... 30

OUTLETS, SPARGER

5002-A – E, K, M, T Sparger Outlets 31
 5002-H Sparger Outlet 32
 5002-R and -RD Sparger Outlets..... 32
 5002 U Sparger Outlet..... 33
 Product Line Cap – Pressureaide® cars 33
 Round Membrane, 5650N Pressureaide® cars 33
 Running Boards, Covered Hopper..... 34
 Rupture Disc Assembly – Pressureaide® cars 35
 Rupture Disc, Replacement – Pressureaide® cars..... 35
 Vibrator Bracket..... 36
 4-Way Valve, Pressureaide® Cars..... 36

OUTLETS, BUTTERFLY

5001A and C Butterfly Outlets..... 18
 5001D Compact Butterfly Outlet 19
 5015 Fluidized Butterfly Outlet..... 20
 Membrane, 5015 Outlet..... 21

TANK CAR

Cap, Plug and Chain Assembly..... 37
 Extension Assembly – 4" Bottom Outlet Valves..... 37
 Lift Assist Kits 37
 Manway Cover..... 38

Manway Cover Hinge Bolts 39
 Manway Cover Seal Bolts..... 40
 Placard Holder 41
 Valve, 2020 Ball Valve, Bottom Outlet 41

Valve, 2040 Ball Valve, Bottom Outlet..... 42
 Valve, 1108 Valve, Safety Relief..... 43
 Valve, 1626 Vacuum Relief Valve..... 43
 Valve, 1148 Valve, Safety Relief..... 44

GENERAL ORDERING INFORMATION

Parts listed in this catalog are readily available for both replacement parts and new car construction.

To derive maximum benefit from this catalog please note the following:

1. Include the part's name, stock part number and drawing number (where available) on your purchase order (Greenbrier's stock part number is provided for each part).
2. If an item you need is not in this catalog, please send drawing(s) along with your inquiry or order. Greenbrier has the capability of providing items unique to your needs.
3. All shipments are quoted FOB our plant.
4. Please send your inquiry and/or order to your Greenbrier Field Representative or to:

GREENBRIER
Rail Services

AFTERMARKET PARTS
2700 N Broadway
Red Oak, IA 51566

P (877) 947-2787
F (888) 868-4793
E parts@gbrx.com

BRAKE PIN		Pin Diameter	Length Under Head to Center of Hole	Reference	Stock Part No.
 ASTM A575 Grade M1020 Hardness 100 BHN Min	1-3/32"	3-0"	3E4425-04	1026836	
		3-3/8"	3E4425-06	1026841	
		3-3/4"	2F0106-03	1026858	
		6-3/8"	3E4425-13	1026846	
		6-5/8"	3E4425-29	1026875	
	1-7/32"	3-0"	2F0107-00	1026856	
	1-11/32"	3-1/4"	3E4427-01	1026850	

CENTER PIN		Length	Diameter	Reference	Stock Part No.
	15" Double taper	1-3/4"	2K2275-01	1024466	
	15" Single taper	2"	1A1558-00	1024142	

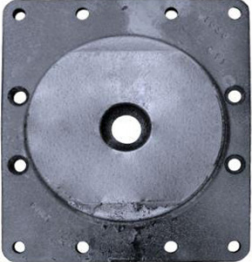
CENTER PLATES		Dimensions	Size	Reference	Stock Part No.
	13-3/4" Diameter 2-3/8" thick, 3/4" flange	without holes	18" x 20-3/8"	4F9279-01	1022879
		with 12 holes		3F1304-00	1022875
	15-7/8" Diameter 3" thick, 3/4" flange	with 12 holes	21" x 20-3/8"	2F8651-00	1022876



CENTER PLATE BOWL LINER (HORIZONTAL)	Outside Diameter	Material	Thickness	Reference	Stock Part No.
	13-1/2"	AISI C1040-1045	1/4"	1G7705-03	1022287
			1/8"	1G7705-04	1022288
			3/16"	1G7705-06	1022289
		Manganese Steel	1/8"	1037151	1037151
			3/16"	1037152	1037152



COUPLER CARRIER WEAR PLATE (DROP IN)	Nominal Thickness	Material	Reference	Stock Part No.
	7/16"	AISI C1050	2H2634-00	1022296
	15/32"	ASTM A128 Manganese Steel AAR S-269	51003167	1022572
	1/2"	Plastic	51000106	1022485

COUPLER CARRIER WEAR PLATE (FLAT)	Nominal Thickness	Material	Reference	Stock Part No.
	1/2"	A514 Type B	1C0270-00	1022309
	3/8"	Carbon Steel 235-241 BHN	1C0270-01	1022310

DRAFT GEAR CARRIER	Dimensions	Reference	Stock Part No.
	<ul style="list-style-type: none"> • 8" wide x 20-3/8" long with (6) 15/16" holes • 17-7/8" between holes 	11-80490-00	1024121

DRAFT KEY	Under head to Center of Hole Dimension	Reference	Stock Part No.
 AAR S-121 ASTM A576 Gr 1050 Hardness BHN 262-302	16-1/2"	3H6878-03	1024397
	17"	3H6878-06	1024400
	17-1/2"	3H6878-01	1024396
	17-3/4"	3H6878-04	1024398
	18"	3H6878-00	1024395
	18-3/4"	3H6878-05	1024399
	19"	3H6878-07	1024401
	19-3/4"	3H6878-08	1024402

DRAFT KEY RETAINER & KEEPER (LOCK)	Description	Reference	Stock Part No.
	<ul style="list-style-type: none"> • Draft Key Retainer • Modified T Head with recess • AAR S-120 	4G6459-00	1022859
	<ul style="list-style-type: none"> • Keeper (Lock) • AAR S-120 	3G6458-00	1022283

DRAFT KEY RETAINER & LOCK	Description	Reference	Stock Part No.
	<ul style="list-style-type: none"> • Draft Key Retainer • "T" Type Head with 1-1/2" Dia Shank • AAR S-120 	11-80472-01	1022858
	<ul style="list-style-type: none"> • Lock • AAR S-120 	3D4510-00	1022857

DRAFT KEY SLOT – REINFORCEMENT	Description	Reference	Stock Part No.
	<ul style="list-style-type: none"> • Cast Steel AAR M-201 Gr B N&T • Use to repair and reinforce the center sill keyway 	4K8449-00	1022127

DRAFT KEY WASHER	Description	Reference	Stock Part No.
	<ul style="list-style-type: none"> • 1/2" thick x 3-1/2" x 8-1/16" • AAR S-120 	1A6443-00	1024148

FOLLOWER BLOCK – Y44	Description	Reference	Stock Part No.
	<ul style="list-style-type: none"> • AAR S-119 Y44A 2-1/4" x 8-13/16" x 12-1/2" • AISI C1050 Q&T 241-311 BHN 	1E8231-00	1022944

FRONT DRAFT LUG	Description	Reference	Stock Part No.
	<ul style="list-style-type: none"> • Weld in design • Fabricated front draft lug suitable for M-901E draft gear pockets 	4W6735-00	1021423

HANDHOLD, ADJUSTABLE – DOUBLE BEND	Description	Min – Max Length	Handhold Offset & Drop	Hole Diameter	Reference	Stock Part No.
	Kit includes Handhold, Grabfoot & Pin	16-1/2" – 22" in 1/2" increments	2-1/2" 3-5/16" Drop	11/16"	2U1880-07	1014755
			3" clearance 4" Drop	11/16"	2U1880-00	1024501

HANDHOLD, ADJUSTABLE – SINGLE BEND	Description	Min – Max Length	Handhold Offset	Hole Diameter	Reference	Stock Part No.
	Kit includes Handhold, Grabfoot & Pin	16" to 25" in 1" increments	2-1/2" 1-3/8" Drop	11/16"	2U1880-06	1014754
		16" to 25" in 1/2" increments		11/16"	2U1880-01	1024502



HANDHOLD, ADJUSTABLE – STRAIGHT	Description	Min – Max Length	Handhold Offset	Hole Diameter	Reference	Stock Part No.
	Kit includes Handhold, Grabfoot & Pin	16-1/8" to 23-5/8" in 1/2" increments	2-1/2"	11/16"	2U1880-03	1024504



HANDHOLD, DOUBLE BEND	Hole Diameter	Span	Drop	Handhold Clearance	Reference	Part No.
	11/16"	18"	3-5/16"	2-1/2"	4D6507-27	1024213
		19"	3-5/16"		4D6507-49	1024215
		18-1/2"	3-1/2"		3F9600-21	1024330
		19-1/2"	3-3/8"		4D6508-01	1024218
		20"	3-1/4"		4D6508-07	1024219
		21"	3-1/4"		3J7707-07	1024442
		22"	3-3/4"	3J7707-08	1024443	
		18"	4"	3J7707-17	1024445	
		18-1/2"	3-5/16"	4D6507-42	1024214	
		19"	3-3/8"	4D6507-50	1024216	
		20"	4"	3J7707-18	1024446	
		22"	3-5/16"	4D6508-31	1024222	
	9/16"	22"	3-15/16"	3"	4D6508-28	1024221

HANDHOLD, SINGLE BEND		Hole Diameter	Span	Handhold Clearance	Reference	Stock Part No.
	11/16"	18"	2-1/2"	4D6511-40	1024230	
		18-1/2"	2-1/2"	4D6511-56	1024234	
		19"	2-1/2"	4D6512-12	1024235	
		20"	2-1/2"	4D6512-30	1024238	
		22"	2-1/2"	4D6512-55	1024241	
	9/16"	17"	2-1/2"	4D6511-20	1024228	

HANDHOLD, STRAIGHT		Hole Diameter	Span	Handhold Clearance	Reference	Stock Part No.
	11/16"	18"	0"	4D6523-13	1024250	
		18-1/2"	0"	4D6523-17	1024252	
		19"	0"	4D6523-21	1024254	
		20"	0"	4D6523-25	1024257	
		22"	0"	4D6523-29	1024260	
	9/16"	18"	0"	4D6523-14	1024251	
		18-1/2"	0"	4D6523-18	1024253	

ROLLER BEARING RETAINER		Description	Reference	Stock Part No.
	M-126 GR A, AAR S-377 Narrow Pedestal Standard S325 for 6-1/2 x 12 Journal	57321010	1022881	

ROPING STAPLE	Description	Reference	Stock Part No.
	With holes	2J3274-01	1024423
	Without holes	2J3274-00	1022210

ROUTE CARD HOLDER	Description	Reference	Stock Part No.
	<ul style="list-style-type: none"> • Aluminum • Mechanically Fastened 	4U5581-01	1020958
	<ul style="list-style-type: none"> • Carbon Steel • Zinc Plated • Welded Application 	2G8768-00	1022295

STRIKER ASSEMBLY	Description	Reference	Stock Part No.
	Fabricated Striker and Front Draft Lug Assembly designed for M-901E draft sills	4W6109-00	1021392

SUPPORT SPRING – HAND BRAKE CHAIN	Description	Reference	Stock Part No.
	<p>The spring is used to prevent the hand brake chain from coming in contact with the axle.</p>	<p>11-82936</p>	<p>1022842</p>

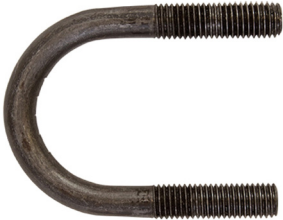
U-BOLT, ANGLE COCK	Description	Reference	Stock Part No.
	<p>Supplied with 5/8" – 11 UNC 2A rolled threads for added strength, accuracy and uniformity as compared to cut threads.</p>	<p>1D4547-01</p>	<p>1027081</p>

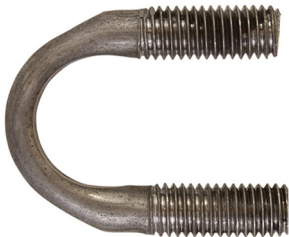
U-BOLT, PIPE CLAMP	Fits Pipe Dia.	Thread	Reference	Stock Part No.
<p>All bolts supplied with rolled threads for added strength</p> 	<p>3/4"</p>	<p>1/2-13 UNC-2A</p>	<p>1D6390-00</p>	<p>1027082</p>
	<p>1-1/4"</p>	<p>5/8-11 UNC-2A</p>	<p>1D6539-00</p>	<p>1027084</p>
	<p>1-1/4"</p>	<p>5/8-11 UNC-2A</p>	<p>1D6391-00</p>	<p>1027083</p>

COVERED HOPPER RAILCAR

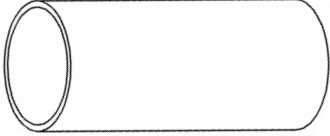
BRAIDED FLEX HOSE – PRESSUREAIDE® CARS	Description	Dimensions	Reference	Stock Part No.
	EPDM Blend – Polyester Reinforced	2-3/8" ID x 15-5/16" L	1J3981-00	1022214
		4-1/2" ID x 11-1/2" L	2J3768-01	1022212
		5-9/16" ID x 9-1/2" L	1J3336-05	1014104
		Hose Clamp 3" long with (2) 7/16" holes, 1-7/8" ID	11-48889	1022312

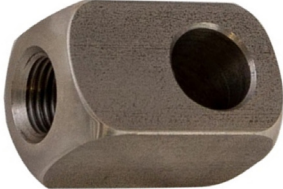

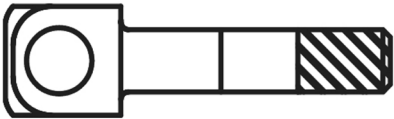
CAMLOCK CONNECTOR – PRESSUREAIDE® CARS	Description	Reference	Stock Part No.
	Camlock Connector Stainless Steel	3V6512-01	1018378

CAMLOCK SWING-BOLTS – PRESSUREAIDE® CARS	Description	Reference	Stock Part No.
	<ul style="list-style-type: none"> • This Camlock Kit consists of one each of: Camlock Handle, Pivot Pin, Connector, Swing Bolt, and Cotter Pin • Handle is carbon steel • Connector and Swing Bolt are stainless steel 	1J3981-00	1022214
	<ul style="list-style-type: none"> • Swing Bolt – Stainless • For 1/2" dia. pins • 1/2"-20 UNF-2A Threads • 3-1/8" overall length 	2J3768-01	1022212

COVERED HOPPER RAILCAR



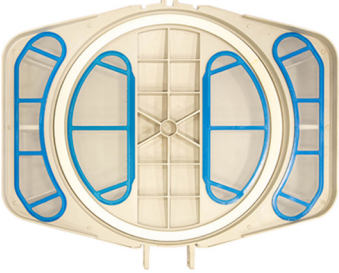

HATCH COVER, 30" ALUMINUM	Description	Reference	Stock Part No.
	<ul style="list-style-type: none"> • Durability of aluminum and light weight (17 lbs.) • No holes in body of cover • Gasket included 	7Y9913-00	1026480
HATCH COVERS, 20" PLASTIC AND ALUMINUM	Description	Reference	Stock Part No.
	20" Plastic Hatch Cover (Gasket Included)	4U0744-04	1022086
	20" Aluminum Hatch Cover 3 point hold-down style (Gasket Included)	4E1819-00	1024288

COVERED HOPPER RAILCAR

HATCH COVER, 20" VENTED	Description	Reference	Stock Part No.
	Vented Cover (includes gasket)	4V0737-01	1021036
	Outer Screen	3W3988-00	1018701
	Inner Screen	3W3989-00	1018702
	Hold Down Assembly	2J2896-00	1024419
	Cam Lock Kit: Stainless Handle, Connector and Swing Bolt, Spacers and Nut 1/2" -13 x 2" Pivot Bolt	2J2897-00	1024421
	Cam Lock Kit: Stainless Handle, Connector and Swing Bolt, Spacers and Nut 3/8" – 16 x 2" Pivot Bolt	2J2897-01	1024422

HATCH COVER, PRESSUREAIDE® CARS	Description	Reference	Stock Part No.
	20" Aluminum Cover with gasket	7Y9489-00	1026284
	Hatch Cover Gasket White, Food Grade	7Y9493-00	1026286

HATCH HANDLE, PRESSUREAIDE® CARS		Description	Reference	Stock Part No.
	<p>Long Handle Hardware Kit (1 each):</p> <ul style="list-style-type: none"> • Handle, D-Pin, Eyebolt & Lock Nut, Hinge Bolt & Nut. Handle has a hole to loop a car seal through • [2 long handle kits required to complete the car seal] 		1048297	1048297
	<p>Complete Hardware Kit</p> <ul style="list-style-type: none"> • 2 Long Handles, 4 Short Handles, Safety Catch, • D-Pins, Eyebolts & Lock nuts, Decal, Hinge Bolts, Nuts, Washers 		5Y5881-01	1024070
MEMBRANE, PRESSUREAIDE®, TRAPEZOIDAL		Description	Reference	Stock Part No.
	<p>Trapezoidal Membrane (5001) 9" x 32" x 32"</p>	Polypropylene Felt	4J4909-00	1022256
	<p>Trapezoidal Membrane (5003) 12-1/4" x 37-3/8" x 41-1/2"</p>	Polypropylene Felt	4K7333-00	1022120
		PP Felt with Kevlar deflector	4K7333-02	1020838
	<p>Trapezoidal Membrane (5750) 26" x 56" x 41"</p>	Polypropylene Felt	4V4636-04	1021144
		with Kevlar deflector	4V4636-05	1021145

OUTLET CAPS	Description		Reference	Stock Part No.
		Aluminum	5G3154-00	1022277
		Molded Plastic	4K5359-00	1022112
	<ul style="list-style-type: none"> Fits 5135, 5135AM, 5235 and 5236 series outlets 	Molded Cap with chain assembly	2J6438-04	1024433
		Aluminum Cap with chain assembly	2J6438-05	1048201
		Cap Gasket White, FDA Approved	1D9484-02	1027222
			<ul style="list-style-type: none"> 5131 outlet Molded Plastic Cap 3/8" mounting holes spaced at 120 degrees 	Without chain
With chain	2J4307-02			1024431

OUTLET, BUTTERFLY – 5001A AND C BUTTERFLY OUTLETS

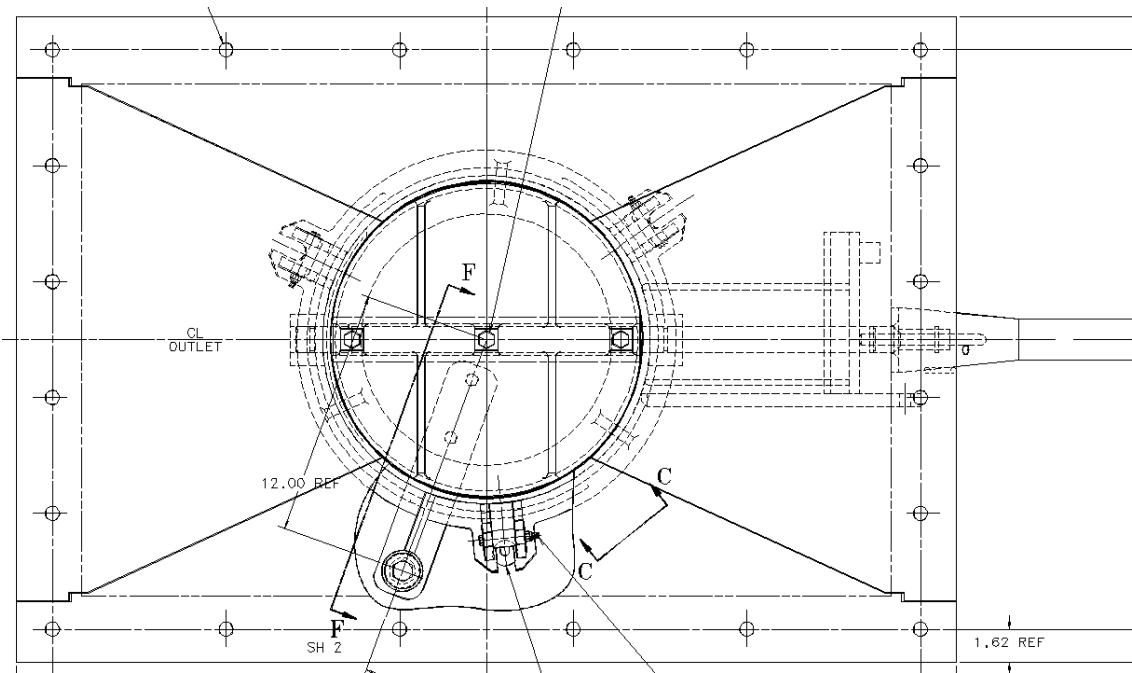

Description	Item	Reference	Stock Part No.
The 5001A and C Butterfly Outlets are designed for controlled gravity discharge of fine powders. Specifically designed for 45-7/8" x 31-1/2" mounting frame using 20 hole bolt pattern (42-3/8" x 28-1/4") Side handle for easy operation	5001A Outlet	5W5785-00	1070956
	5001C Outlet	5Y5484-01	1024033
Door (Cover)		67-9732-01	1024109
Handle Assembly		3W5788-00	1018854
Fabricated Pan Assembly	5001A Outlet	5W5790-01	1071012
Fabricated Pan Assembly	5001C Outlet	5Y5486-01	1024034
Pivot Assembly		3W6741-00	1019016

OUTLET, BUTTERFLY – 5001D COMPACT BUTTERFLY OUTLET

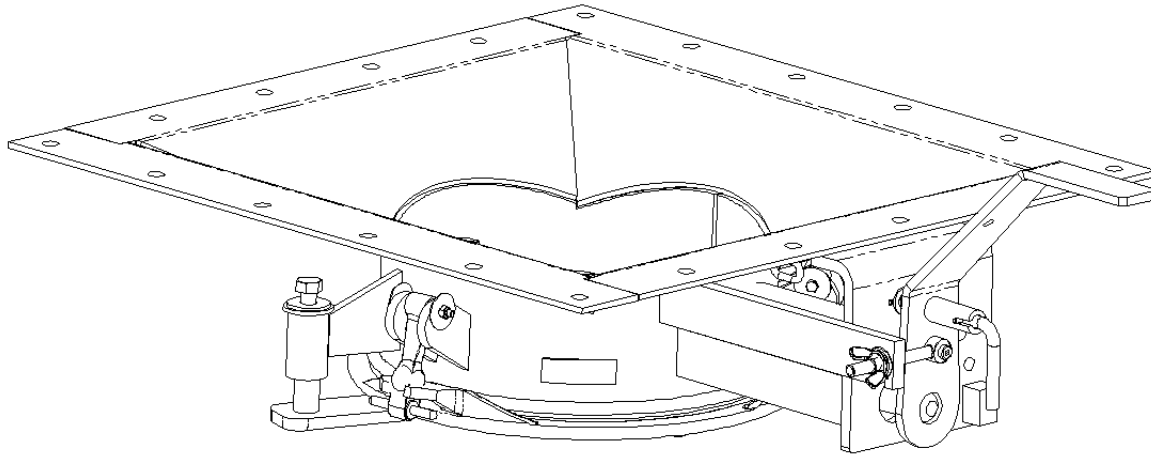

Description	Item	Reference	Stock Part No.
<ul style="list-style-type: none"> The 5001D Compact Butterfly Outlet is designed for controlled gravity discharge of fine powders. Specifically designed for 32-13/16" x 32-1/2" mounting frame using 20 hole bolt pattern (30-1/4" x 30-1/4") Side handle for easy operation 	Outlet Assembly	1065949	1065949
Door (Cover)		67-9372-01	1024109
Handle Assembly		3W5788-00	1018854
Pan Assembly		1065369	1065369

OUTLET, BUTTERFLY – 5015 FLUIDIZED BUTTERFLY OUTLET

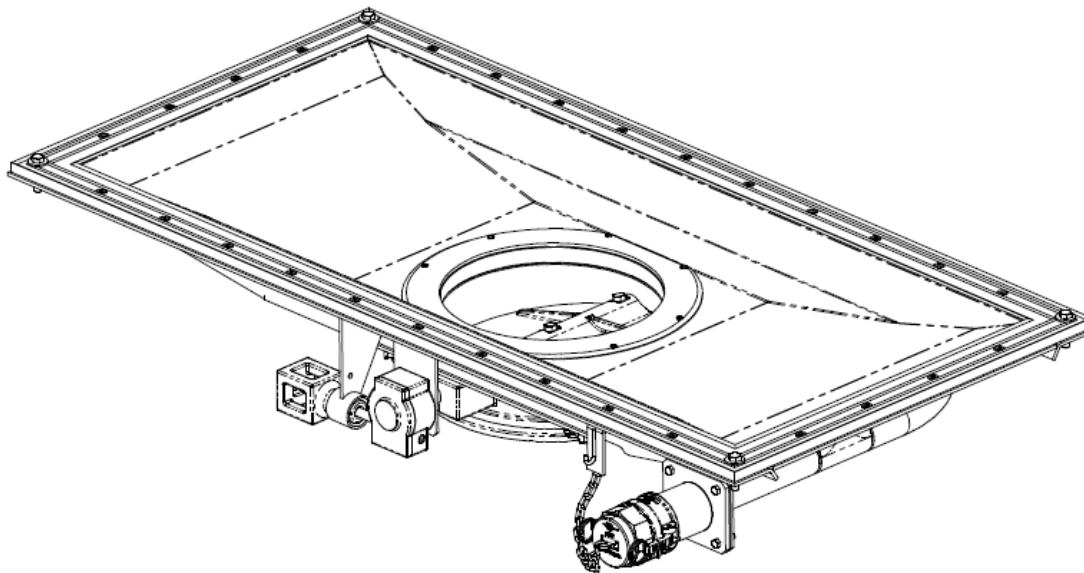

Description	Item	Reference	Stock Part No.
<ul style="list-style-type: none"> The 5015 Fluidized Butterfly Outlet is designed for controlled gravity discharge of fine powders with fluidized assist. Using low pressure air, powder loadings fluidize to flow as freely as liquids. 16" cylindrical discharge port with butterfly valve controls the flow rate. Sanitary door protects against contamination in transit. 		1053090	1053090
Cloth Membrane Adapter Kit		1003320	1003320
Sanitary Door Assembly		2H1944-00	1024384
Pan Assembly		1049903	1049903
Capstan		3U7381-00	1017915
Gearbox		3Y0372-00	1019586
Air Inlet Assembly		4U7214-00	1020976
Membrane Retainer Assembly		4Y0843-00	1021622
Sanitary Door Gasket		11-85419-02	1027215

COVERED HOPPER RAILCAR

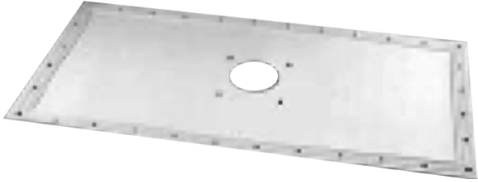
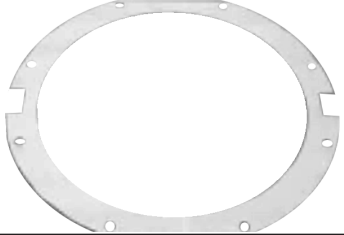
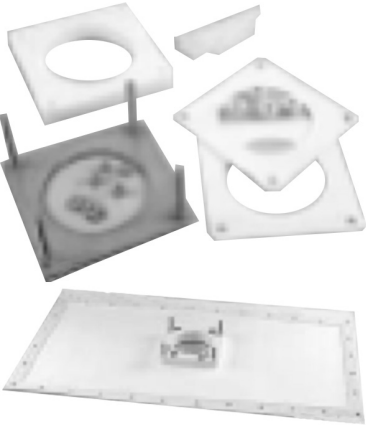
OUTLET, BUTTERFLY – MEMBRANE, 5015 OUTLET	Description	Reference	Stock Part No.
	Cloth with Gasket	91001373	1027338
OUTLET, BUTTERFLY – MEMBRANE, 5015 OUTLET – BOTTOM ADAPTER GASKET	Description	Reference	Stock Part No.
	Fits 5015 Outlet	91001378	1027341
OUTLET, BUTTERFLY – MEMBRANE ADAPTER KIT, 5015 OUTLET	Description	Reference	Stock Part No.
	Kit Includes: <ul style="list-style-type: none"> • Membrane & Gasket • Membrane Mounting Adapter • SST Membrane Retainer • Side Adapter Scuff Strip • Bottom Membrane Gasket • Adapter O-ring Seal • Latex Gloves 	91001333	1004404

OUTLET, GRAVITY – 5021C GRAVITY OUTLET

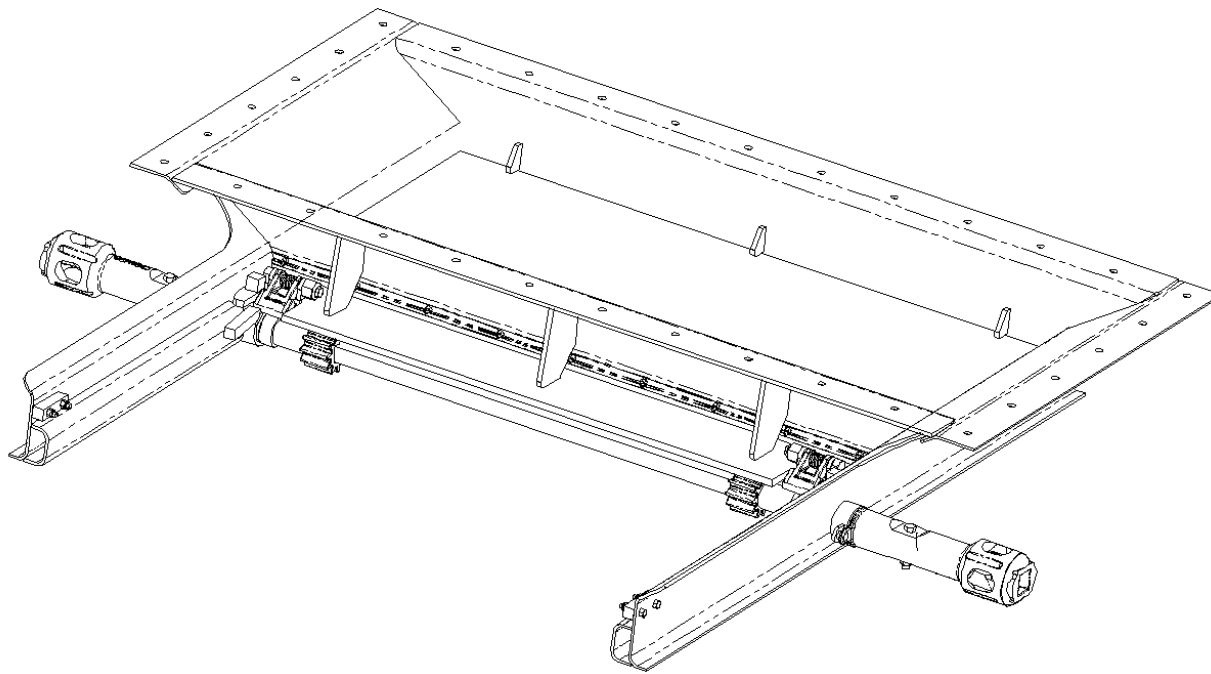

Description	Item	Reference	Stock Part No.
<ul style="list-style-type: none"> Gravity Slide Gate Outlet with 25" x 48" opening Dimensions: 70-1/2" x 35-1/2" x 10" Fits 32 bolt mounting pattern 67-1/8" x 31-1/2" 	Outlet Assembly	7Y6813-01	1025046
Pan Assembly		7Y6994-01	1025163
Gate Assembly		7Y6869-01	1025106
Capstan		4U7198-00	1020975
Pinion		3U7252-00	1017912
Brush Seal		3Y4958-02	1020388
Shaft		7Y6884-00	1025113

OUTLET, GRAVITY – 5097E AND F GRAVITY OUTLETS

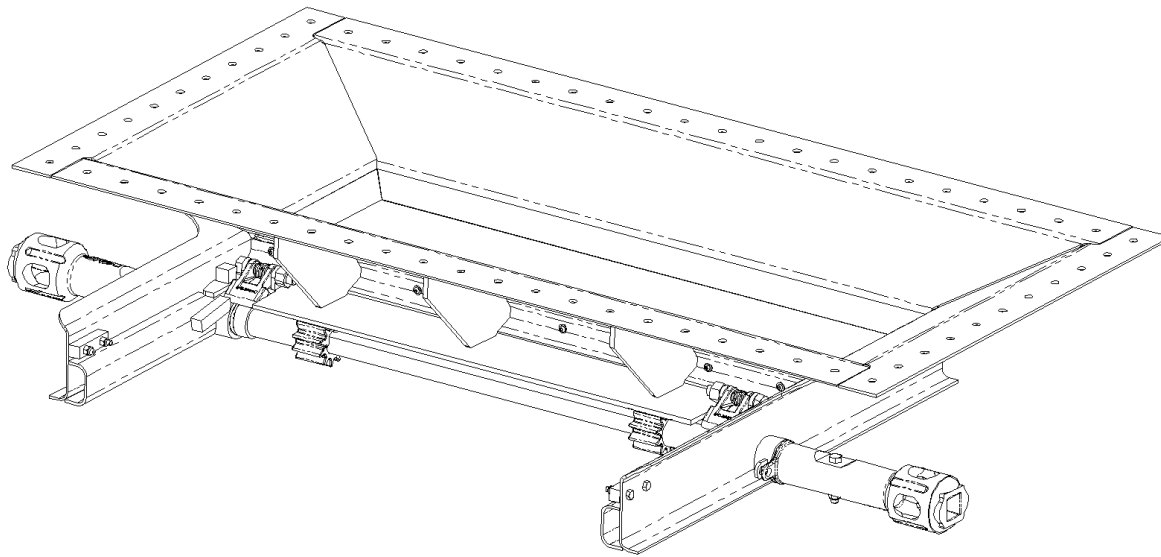

Description	Item	Reference	Stock Part No.
<ul style="list-style-type: none"> This outlet meets or exceeds all GEAPS and AAR S-233-92 performance specifications A heavy duty outlet that features an automatic locking device and a fixed capstan. Designed with lower opening torque. Ledge-less design prevents product build-up. 			
The 5097E gravity outlet features a 13" x 48" opening with brush seals.	5097E	7Y7355-00	1025294
The 5097E gravity outlet features a 15" x 45" opening with UHMW Seals.	5097F	1067172	1067172
Pinion	Common Parts	3U7252-00	1017912
Shaft		7Y6884-02	1025114
Capstan		4U7198-00	1020975
Gate Assembly		7Y7353-00	1025293
Pan Assembly	5097E Parts	7Y7352-00	1025292
Brush Seals		3Y4958-05	1055679
		3Y4958-06	1055680
Seal Covers		7Y7362-00	1025299
	7Y7363-00	1025300	
Pan Assembly	5097F Parts	1067128	1067128
UHMW Seals		1067205	1067205
		1067206	1067206

OUTLET, GRAVITY – 5098D GRAVITY OUTLET

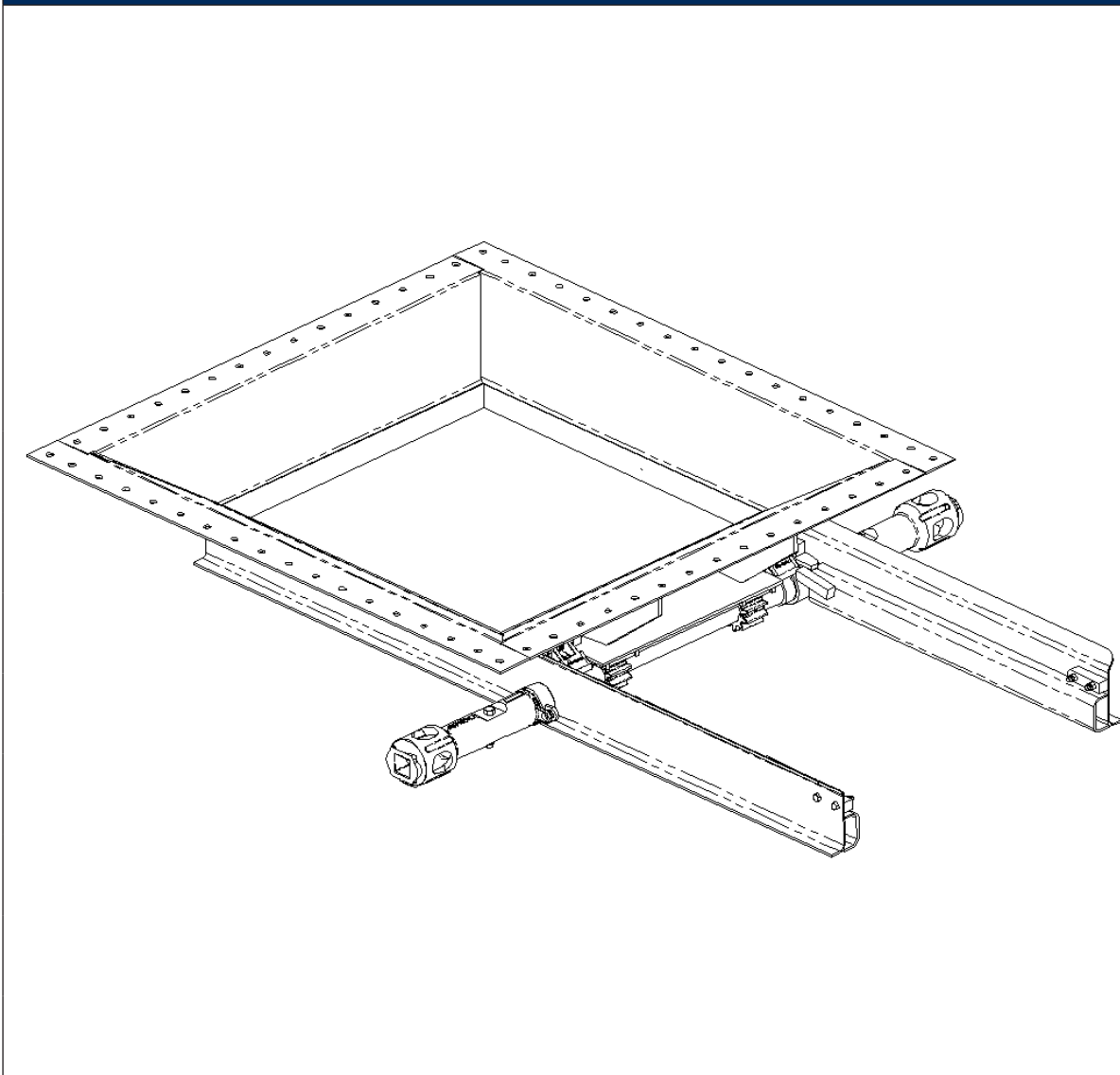

Description	Reference	Stock Part No.
Outlet Assembly <ul style="list-style-type: none"> • The 5098D gravity outlet features a 31" x 29" opening. • It meets or exceeds all GEAPS and AAR S-233-92 performance specifications. • A heavy duty outlet that features an automatic locking device and a fixed capstan. • Designed with lower opening torque. • Ledge-less design prevents product build-up. 	7Y9209-00	1026169
Pinion	3U7252-00	1017912
Shaft	7Y6884-03	1025115
Capstan	4-U7198-00	1020975
UHMW Front Seal	1055274	1055274
UHMW Back Seal	1055117	1055117
UHMW Side Seal	7Y9226-00	1029077
Gate Assembly	7Y9161-00	1029073
Pan Assembly	7Y7944-00	1029062

OUTLET, GRAVITY – 5124 AL GRAVITY PNEUMATIC OUTLET WITH SANITARY SHIELD

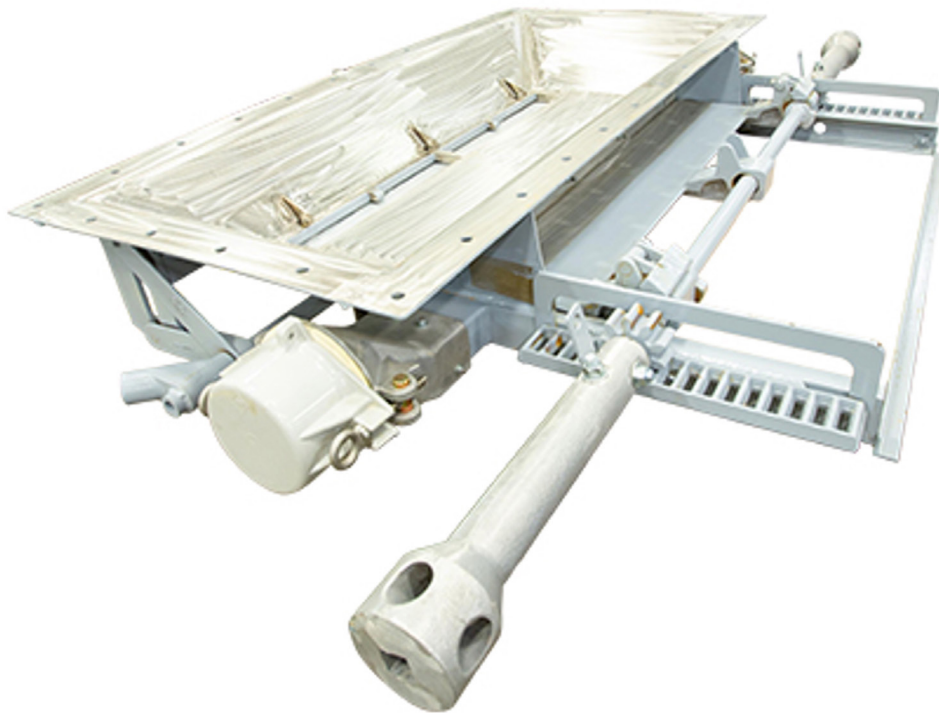

Description	Reference	Stock Part No.
The 5124 Auto-Lock gravity pneumatic outlet is designed for product purity featuring unobstructed gravity discharge with the pneumatic opening outside the gravity discharge area for maximum flow rate and optimal clean-out.		
Carbon Steel Outlet	5W9017-12	1023535
Gate & Pinion Assembly	5W9018-00	1023536
Pan Assembly	5W9533-00	1023567
304L Stainless Steel Outlet (product contact surfaces)	5W9017-10	1023534
Gate & Pinion Assembly	5W9018-04	1023537
Pan Assembly	5W9534-04	1023570
Nozzle & Cap Assembly	41-80492-00	1024123
Nozzle Assembly	3C8452-00	1004281
Sanitary Shield Assembly	5F3043-00	1004275
Capstan	3B3401-00	1022405
Aluminum Outlet Cap	41-80615-00	1024126
Cap Gasket	2F0807-01	1026921
Cap Lock Eye Bolt	1B3836-00	1027077
Bottom Seal – Gravity Gate	11-85719-00	1024138
Bottom Seal Retainer	11-79520-00	1024118
Top Seal – Gravity Gate	1G7748-00	1024367
Top Seal Retainer	1G7749-00	1024368
Seal Retainer, Short Side – Sanitary Shield	1E9910-00	1024311
Seal Retainer, Long Side – Sanitary Shield	1E9910-01	1024312
Gasket – Sanitary Shield	2E9909-01	1022177
Outlet Seal Spring	11-80353-00	1022847
Gate Seal Spacer	11-80289-00	1022462

OUTLET, PNEUMATIC – 5129A PNEUMATIC OUTLET

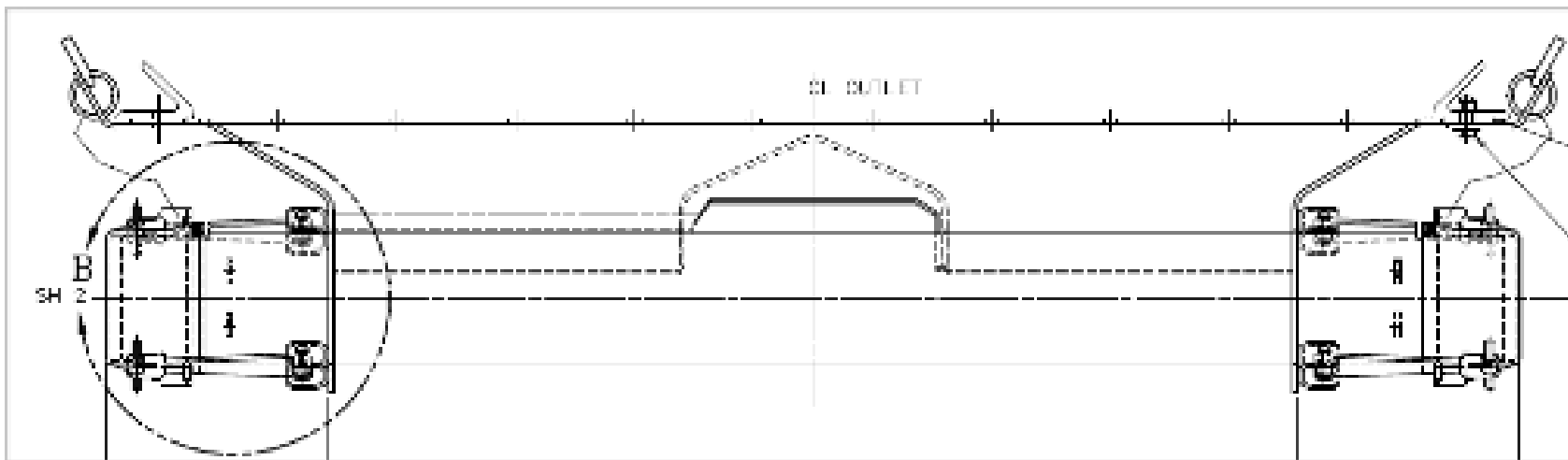

Description	Item	Reference	Stock Part No.
<ul style="list-style-type: none"> • Standard Outlet for Peanut Service • Dimensions: 70" x 34-3/8" x 14" Deep • Fits 32 bolt mounting pattern 67-1/8" x 31-1/2" 	Outlet Assembly	5V9030-01	1053089
Pan Assembly		5V9198-01	1053964
Outlet Cap		4K5359-01	1053442

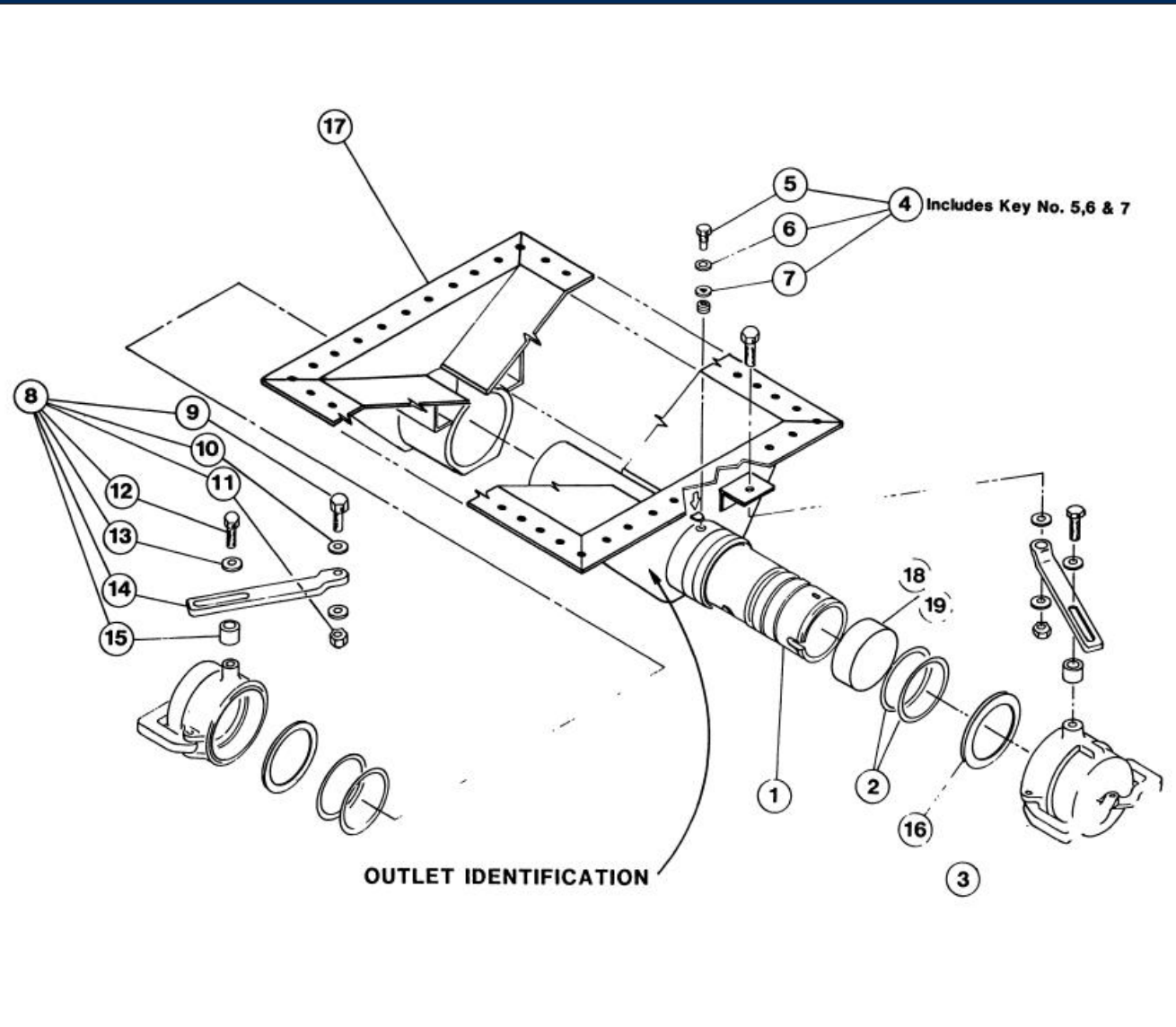

OUTLET, PNEUMATIC – 5230 PNEUMATIC OUTLET



Description	Item	Reference	Stock Part No.
Airtight – Quick Coupling Pneumatic Outlet for Pressure-in-Transit cars. Typically used in Nylon 6 (polycaprolactam) service.	Outlet Assembly	6J5813-01	1024428
Control Valve	1	6B8106-01	1022917
Cap	3	3J5815-00	1022236
Pan Assembly	17	5J5814-01	1022981

OUTLET, PNEUMATIC – 5236 PNEUMATIC OUTLET		Description		Reference	Stock Part No.
	<ul style="list-style-type: none"> The premier plastic pellet service outlet allows product sampling without flooding the product tube. Serrated control valve for greater flow control. On the car clean-out with removable aluminum adapters. Tamper proof lock-bolts. 	5236J		5U3640-10	1074956
		5236K With tamper resistant Torx bolts to secure the adapter		5U3640-08	1074461
		Control Valve		1071290	1071290
		Long Shaft		1069577	1069577
		Left Control Valve Handle		3U4279-00	1017781
		Right Control Valve Handle		3U4279-01	1017782
		Handle Lock (RH J Bolt)		3K4922-00	1017471
		Handle Lock (LH J Bolt)		3K4923-00	1017472
		Cap Lock Bolt with Seal Provision		4Y1588-01	1021678
		Cap Lock Eye Bolt		3K9493-00	1022138
		Instruction Decal		5W4124-00	1023295
		Hardware (32 Cap Screws & Nuts, 64 Washers)		2J9094-01	1024459
		End Adapter Gasket		4U9104-00	1020996

OUTLET, PNEUMATIC – ADAPTERS		Description		Reference	Stock Part No.
	Aluminum adapter only	Fits Outlet:	5236	5U4070-00	1036833
			5135	4G7156-00	1022278
	5236 Outlet Aluminum adapter with shafts, handles, handle lock, tamper prevention eyebolts, and gaskets to interface to the outlet and cap.	Hinge:	Equipped so that adapter can swing away.	5U3928-01	1004308
			No Hinge – drop adapter to clean the outlet bore.	5U3928-09	1023036

OUTLET, PNEUMATIC – GASKET	Description:	Reference	Stock Part No.
	<ul style="list-style-type: none"> • Fits 5235 outlets built after 1996 and 5236 outlets • Dovetail Design prevents pellet entrapment 	3V4168-00	1018229
	<ul style="list-style-type: none"> • Dual Bulb Design • White • FDA approved 	2K9339-00	1027200

OUTLET, PNEUMATIC – 5134B FLUIDIZED PNEUMATIC OUTLET

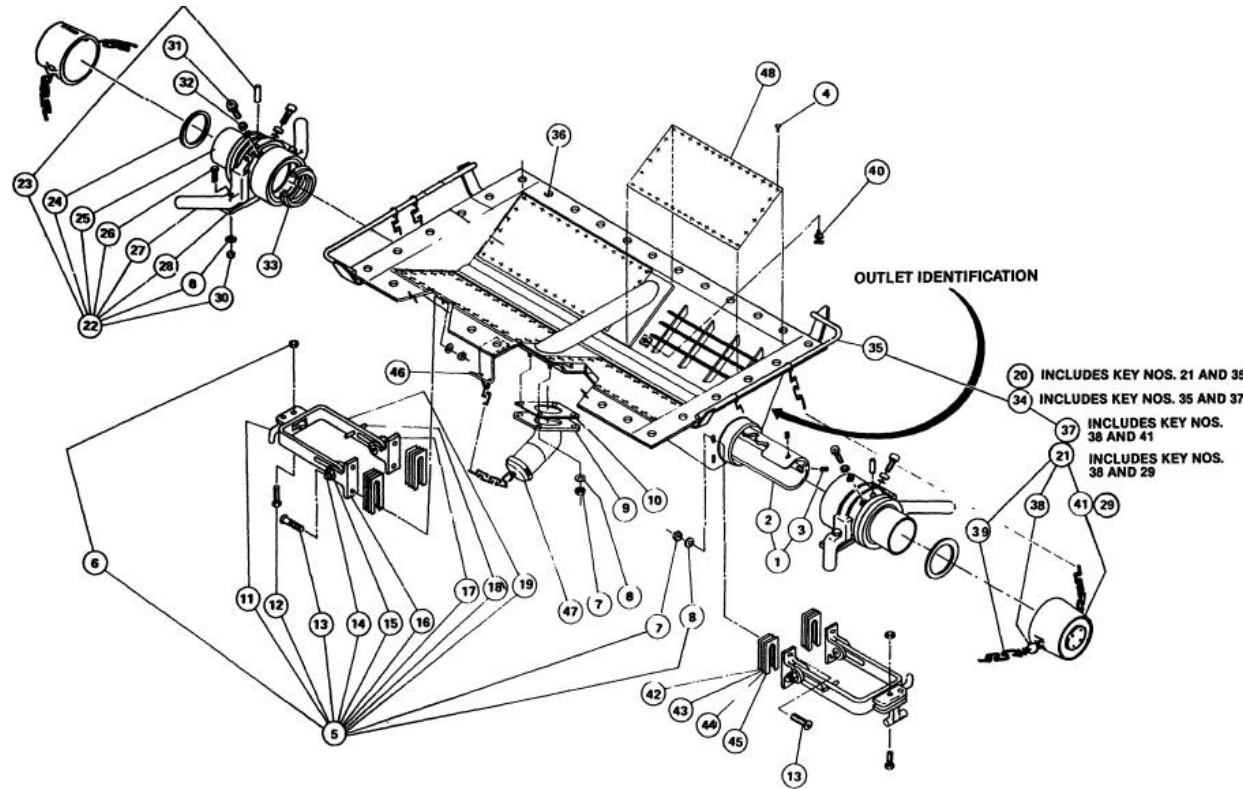

Description	Item	Reference	Stock Part No.
<p>The fluidized adjustable pneumatic 5134 outlet is designed to quickly and easily unload the tough powders that tend to bridge and column during discharge.</p> <p>The system introduces low pressure air through the permeable stainless steel outlet slope sheets, fluidizing the lading so it flows freely to the outlet opening.</p> <p>The outlet also offers the flexibility of unloading free flowing materials without using fluidizing air.</p>	Outlet Assembly	6J8145-02	1024448
Control Valve with Insert	1	6E1374-01	1024287
Air Inlet Assembly	9	3G0551-00	1004284
Air Inlet Cap	47	4K5359-00	1022112
End Adapter Assembly	22	6H7622-03	1004295
Pan Assembly	36	6F9133-01	1024329
Outlet Cap Assembly	38	3G7751-03	1022279
Membrane	48	5G4753-00	1022476

OUTLET, SPARGER – 5002-A – E, K, M, T SPARGER OUTLETS

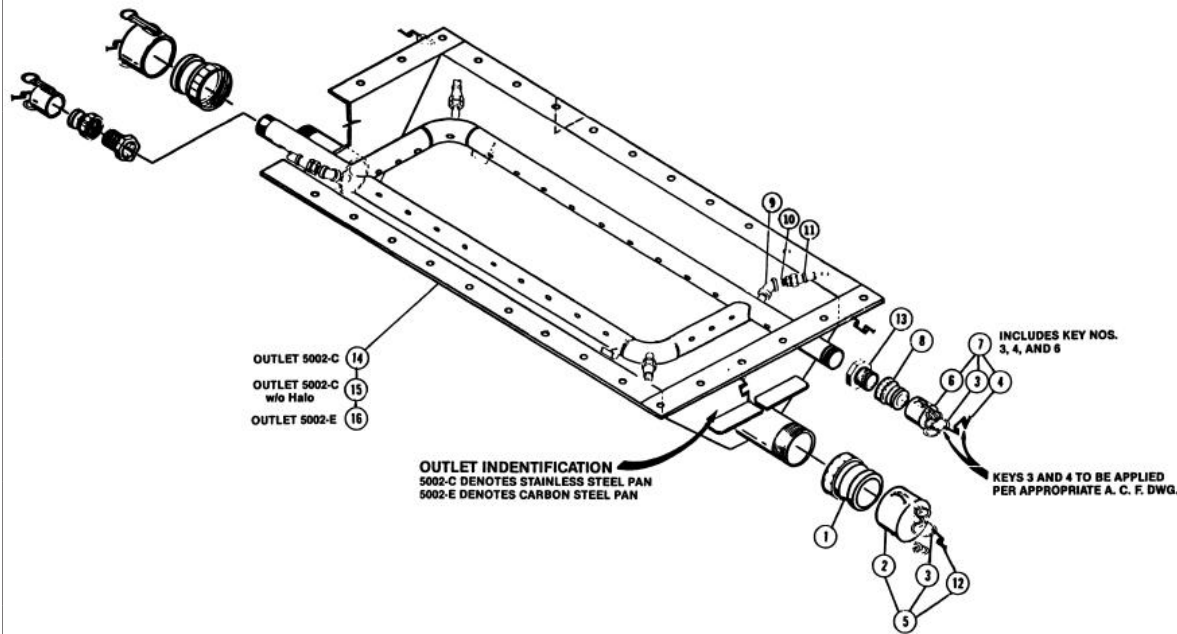

Description	Item	Reference	Stock Part No.
For products shipped in a dry state but offloaded in a wet state. Our premier Sparger outlet is available in carbon steel or stainless, standard with threaded air inlets.			
304 Stainless Pan – 2-1/2" Air Inlet	5002A	6G8474-00	1024375
Carbon Steel Pan – 2" Air Inlet	5002B	6G8474-01	
304 Stainless Pan – 2-1/2" Air Inlet with Risers at Halo Corners	5002C	6G8474-02	
Carbon Steel Pan – 2-1/2" Air Inlet	5002D	6G8474-03	
Carbon Steel Pan – 2-1/2" Air Inlet with Risers at Halo Corners	5002E	6G8474-04	1066803
316L Stainless Pan – 2-1/2" Air Inlet with Risers at Halo Corners	5002K	6G8474-09	
Carbon Steel Pan – 2-1/2" Air Inlets	5002M	5V4024-00	
316L Stainless Pan – 2-1/2" Air Inlets with Risers at Halo. Corners with plastic 2-1/2" and 4" dust caps	5002T	6G8474-13	1024376

OUTLET, SPARGER – 5002-H SPARGER OUTLET

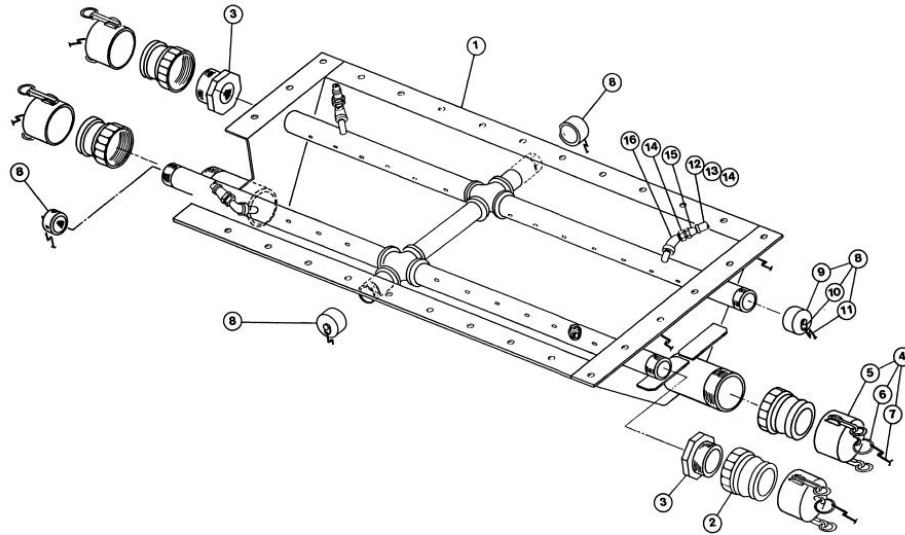

Description	Item	Reference	Stock Part No.
5002 H Carbon Steel Pan – 2-1/2" "H" Type Halo with 1" Risers	Outlet Assembly	6G8474-08	

OUTLET, SPARGER – 5002-R AND -RD SPARGER OUTLETS

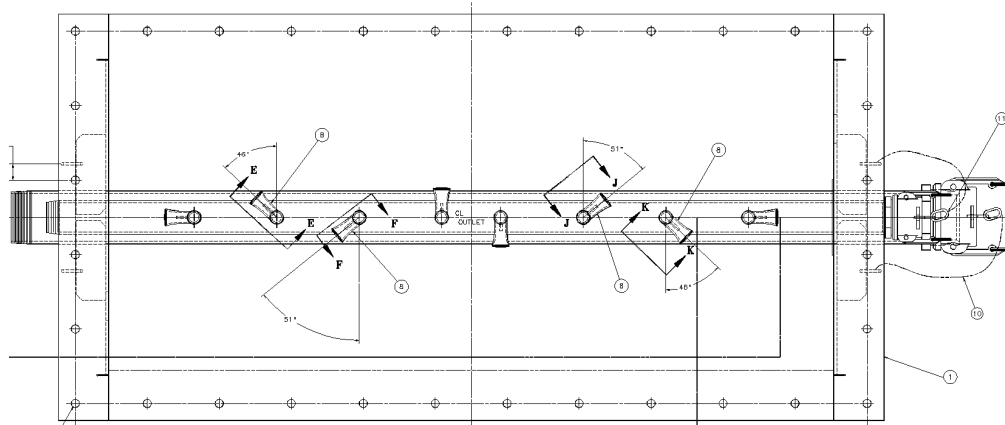

Description	Item	Reference	Stock Part No.
316 Stainless Steel Pan – 2-1/2" Straight Halo with 8 – 1" Risers	5002-R	5W7593-00	1023430
316 Stainless Steel Pan – 2-1/2" Straight Halo with 8 – 1" Risers and 2 Cleanout Nozzles	5002-RD	5W7593-01	1023431
Pan Assembly		6G8469-04	1024374

OUTLET, SPARGER – 5002 U SPARGER OUTLET	Description	Item	Reference	Stock Part No.
	<ul style="list-style-type: none"> • 5002 U Stainless Steel Pan – 2-1/2" Halo with Riser connection • 70" length x 34-3/8" width x 13-5/16" depth • Fits 32 bolt mounting frame pattern 67-1/8" x 31-1/2" 	Outlet Assembly	1060682	1060682
	316 Stainless Steel Pan Assembly		1060719	1060719

PRODUCT LINE CAP – PRESSUREAIDE® CARS	Description	Reference	Stock Part No.
	<ul style="list-style-type: none"> • 5" Camlock Cap • Aluminum cap with white food grade gasket • Features an alignment tab and seal provision 	3J9816-00	1017410



ROUND MEMBRANE, 5650N PRESSUREAIDE® CARS	Description	Reference	Stock Part No.
	Round Membrane with heat deflector, 43-1/2" bolt circle	4Y4198-01	1021906

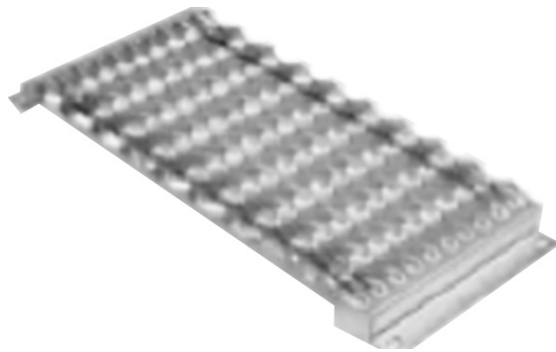

RUNNING BOARDS, COVERED HOPPER

The Diamond Tread design features a stress relief hole at the edge of the diamond pattern that prevents running board cracks.



Description	Reference	Stock Part No.
End Platform 8" W x 60.75" L 9/16" x 1-1/8" Slotted Holes	4K3890-04	1020830
Roof Running Boards: All boards listed below are 24.63" Wide:		
Crossover C Board 47.25" L	4K3169-02	1020743
Lateral A Board 12.38" L	3K3167-10	1017424
Center B Board 127.13" L	4K3168-04	1020741
End BSP Board 127.13" L With handhold mounting provision	4K3171-03	1020744
Intermediate B-1 155.25" L	4K3799-19	1020765
Intermediate B-1 141.75" L	4K3799-20	1020766
Intermediate B-1 132.75" L	4K3799-21	1020767
Intermediate B-1 95.63" L	4K3799-30	1020775
Intermediate B-1 88.88" L	4K3799-28	1020773
Intermediate B-1 74.25" L	4K3799-29	1020774

RUPTURE DISC ASSEMBLY – PRESSUREAIDE® CARS	Description	Reference	Stock Part No.
	Rupture Disc Assembly for Pressuraide® Applications	3J5612-00	1022233
RUPTURE DISC, REPLACEMENT – PRESSUREAIDE® CARS	Description	Reference	Stock Part No.
	Rupture Disc for Pressuraide® Applications	2J5615-00	1022232

VIBRATOR BRACKET	Description	Reference	Stock Part No.
	<p>Cast steel vibrator bracket suitable for welding directly to hopper side slope sheets</p>	<p>4K8592-00</p>	<p>1022131</p>
4-WAY VALVE, PRESSUREAIDE® CARS	Description	Reference	Stock Part No.
	<p>4-way valve</p> <ul style="list-style-type: none"> • Controls air flow to near side and far side plenums • Used on Pressureaide® models 5001, 5003 and 5007 	<p>6J5997-00</p>	<p>1024429</p>
	<p>Rebuild Kit</p> <ul style="list-style-type: none"> • Contains a plastic fluidizing valve, bushing, O-rings, snap ring, and epoxy 	<p>3V4695-00</p>	<p>1018249</p>



CAP, PLUG AND CHAIN ASSEMBLY	Description	Reference	Stock Part No.
	<ul style="list-style-type: none"> • 4" Outlet Cap • 2" Plug & Chain • Carbon Steel 	4Y0572-00	1021612
	<ul style="list-style-type: none"> • 4" Outlet Cap • 2" Plug & Chain • Stainless Steel 	4Y0572-05	1021613

EXTENSION ASSEMBLY – 4" BOTTOM OUTLET VALVES	Description		Reference	Stock Part No.
	Extensions have (4) 11/16" diameter holes on 9" bolt circles.	Carbon Steel, 5-7/8" Height	3V8544-01	1018456
		Carbon Steel, 5-15/16" Height	2G5709-01	1037490
		316 Stainless Steel, 5-13/16" H	3U0569-03	1017567

LIFT ASSIST KITS	Description	Reference	Stock Part No.
	Top Unloading Housing Kit	1037989	1037989
	Manway Cover Kit	1048327	1048327





MANWAY COVER	Description		Reference	Stock Part No.
	6 Bolt – 20" Diameter	Cast Carbon Steel	5U5231-09	1023051
		Cast Stainless Steel	5U5231-02	1023050
	8 Bolt – 20" Dia with Lift Assist Mounting Holes	Cast Carbon Steel	3Y4225-00	1020287
		Cast Stainless Steel	3Y4225-03	1020288

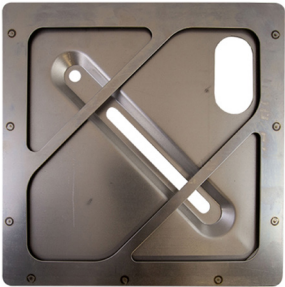

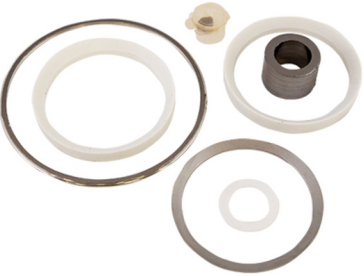

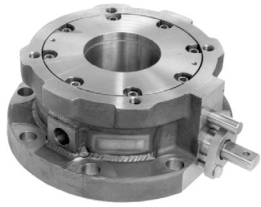
MANWAY COVER HINGE BOLTS		Description	Material	Reference	Stock Part No.
	Hinge Bolt Assembly • Bolt, Nut, Washer • 7/8"– 9 UNC Threads • Hex Head Nuts	For 3/4" Dia Hinge Pins	Carbon Steel	00024176	1007869
		For 1" Dia Hinge Pins	Carbon Steel	00030922	1011372
	Hinge Bolts • 7/8"– 9 UNC 2A Threads	For 3/4" Dia Hinge Pins	Carbon Steel	3V9009-02	1018476
		For 1" Dia Hinge Pins	Carbon Steel	3V9009-08	1018477
			Stainless Steel	3V9009-09	1018479
	Hex Nuts • 7/8"– 9 UNC 2B Threads	Heavy Hex	Carbon Steel	90002254	1026624
		Heavy Hex, Zinc Plated	Carbon Steel	91002109	1027356
	Washers	15/16" ID x 2-1/4" OD x 5/16" Thick	Carbon Steel	91005432	1027581
			Stainless Steel	91005847	1004036
	Hinge Pins	1" Dia Hex Head Hinge Pin, Washer, Cotter Pin	Carbon Steel		1035098
		1" Dia Hex Head Hinge Pin	Carbon Steel	2W0597-00	1015657
			Stainless Steel	2W0597-02	1015658
		3/4" Dia Hex Head Hinge Pin	Carbon Steel	2K2561-00	1026889

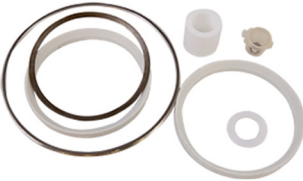

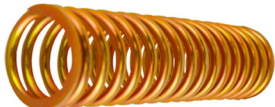

MANWAY COVER SEAL BOLTS		Description		Material	Reference	Stock Part No.
	Seal Bolt Assembly	7/8" – 9 UNC Threads Hex Head Seal Nuts	For 1" Dia Hinge Pins	Carbon Steel	2E3083-04	1014233
			For 3/4" Dia Hinge Pins	Carbon Steel	2E3083-06	1014235
	Square Head Seal Nuts	For 3/4" Dia Hinge Pins	Carbon Steel	2E3083-00	1024295	
	Seal Bolts	7/8" – 9 UNC-2A Threads	For 3/4" Dia Hinge Pins	Carbon Steel	1B0163-00	1026536
			For 1" Dia Hinge Pins	Carbon Steel	3V9018-02	1018483
				Stainless Steel	3V9018-03	1018484
	Seal Nuts	Hex Head Seal Nut	7/8" – 9 UNC-2B Threads	Carbon Steel	2U1581-07	1014698
				Stainless Steel	2U1581-05	1014697
		Square Head Seal Nut	7/8" – 9 UNC-2B Threads	Carbon Steel	1B0164-00	1026648
	Ferrule			Carbon Steel	1A0680-00	1024139
				Stainless Steel	1C0749-01	1052829

PLACARD HOLDER	Description	Reference	Stock Part No.
	12-1/2" square placard holder with an adjustable mounting slot and a push slot for quick card removal	3K5986-00	1022121 Unpainted
		3V3424-00	1018205 Black Powder Coated

VALVE, 2020 BALL VALVE, BOTTOM OUTLET	Description	Reference	Stock Part No.
	<ul style="list-style-type: none"> • S2020 Low Profile Valve • 3" Full Throat Ball Valve • 3-11/16" Depth • Stainless steel body and trim 	6U1577-01	1024498
	<p>Parts Rebuild Kit:</p> <ul style="list-style-type: none"> • (2) Ball Seals • (1) Packing Seals • (1) Spring Washer • (1) Stem Gasket • (1) Cover Gasket 	2U07780-00	1015038

VALVE, 2040 BALL VALVE, BOTTOM OUTLET	Description		Reference	Stock Part No.
	Low Profile Ball Valve, 4" Full Port			
	Valves	Carbon Steel Body, Stainless Trim Steam Jacketed, 1-1/2" NPT	5Y0689-00	1023662
		Carbon Steel Body, Stainless Trim Steam Jacketed, 1-1/2" NPT with 2 square head plugs	5Y0689-04	1023664
		Stainless Steel Body and Trim Steam Jacketed, 1-1/2" NPT	5Y0689-01	1023663
	Parts	Steam Jacketed CS Valve Body	5U3487-06	1023017
		Steam Jacketed SS Valve Body	5U3487-07	1023018
		Carbon Steel Valve Cover	4U1879-00	1020896
		Stainless Steel Valve Cover	4U1879-01	1020897
	Stainless Steel Ball		4U3493-00	1020928
	Rebuild Kit (2) Ball Seals (1) Packing Seals (1) Spring Washer (1) Stem Gasket (1) Cover Gasket		51000138	1022488
	Packing Gland		3W5973-00	1018881
	Stainless Steel Valve Stem		3W6024-00	1018886

VALVE, 1108 VALVE, SAFETY RELIEF	Description		Reference	Stock Part No.
	<ul style="list-style-type: none"> • 75 psi set pressure • 1,044 SCFM @ 85 psi • Tongue & Groove Gasket Mount • Carbon Steel Valve with Stainless Trim 	Viton A O-Rings	4K8048-04	1020843
		Viton GF-S O-Rings	4K8048-26	1020850
		Nitrile 70 O-Rings, Food Grade	4K8048-15	1024473
	Parts	Carbon Steel Valve Body	4K8052-00	1020859
		Stainless Steel Stem	3K8055-00	1017519
		Spring – Zinc Plated	2K8041-00	1022855
VALVE, 1626 VACUUM RELIEF VALVE	Description		Reference	Stock Part No.
	<ul style="list-style-type: none"> • 1626 Vacuum Relief Valve, 2-1/2" NPT • Sight glasses provide visibility that the valve is seated • 3 psi neg pressure • Model S1626A Stainless Steel Valve • Viton GF-S Carolina Seal Quad Ring 		4Y2535-06	1021780

VALVE, 1148 VALVE, SAFETY RELIEF	Description		Reference	Stock Part No.
	Valve <ul style="list-style-type: none"> • 75 psi set pressure • 20,605 SCFM @ 85 psi • Flat Face Gasket Mount 	Carbon Steel Valve with Stainless Steel Trim	4U4722-09	1020939
		Nitrile 70 O-Rings, Food Grade Viton GF-S Carolina Seal 5350 O-Rings	4U4722-14	1020942
	Parts	Carbon Steel Valve Body	4U4726-00	1020945
		CS Valve Seat Guide (not shown)	3U4728-00	1017790
		Stainless Steel Stem	3U8720-00	1017966
		Spring – Zinc Plated	2U4720-00	1014850